

33 800 861



- Saliente 200 mm
- Caño giratorio 360°
- Posibilidad de limitar la rotación con un juego de límite de giro 12 820 970 90
- Chorro mezclado con aire
- Caudal máx. 8 l/min con 3 bares de presión hidráulica
- Sin plomo
- Este producto puede ayudar a un edificio a cumplir con los requisitos de los sistemas de certificación ecológica de edificios: LEED®, BREEAM®, DGNB

	Cromo	33 800 861-00
	Platino cepillado	33 800 861-06
	Platino	33 800 861-08
	Latón (Oro 23k)	33 800 861-09
	Dark Chrome	33 800 861-19
	Latón cepillado (Oro 23k)	33 800 861-28
	Negro mate	33 800 861-33
	Champagne cepillado (Oro 22k)	33 800 861-46
	Champagne (Oro 22k)	33 800 861-47
	Cromo cepillado	33 800 861-93
	Dark Platinum cepillado	33 800 861-99

Complementos recomendados

Juego de limitación de giro - 12 820 970 90



Complementos recomendados

Accionamiento excéntrico manual con maneta de control giratoria - Cromo 10 712 970-00



Complementos recomendados

Dispensador sin roseta - Cromo 82 424 970-00



33 800 861



Diagrama de flujo



Certificado

LGA_38642.

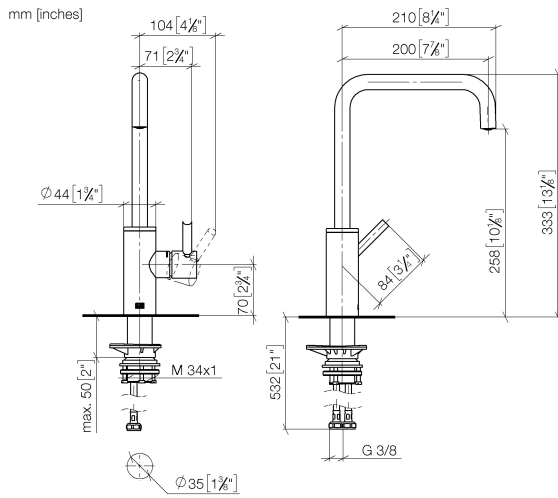
WRAS_240102021.

33 800 861

